

ONE BRAND. ONE POWER.

TOTAL CONTROL

1805KW

Stage III

16 cylinders

FOGO GENSET ENGINE

F0523-2003

The F0523-2003 represents cutting-edge power generation technology with 1600 kW of prime output capability. This 16-cylinder 52.3L engine features sophisticated water-air intercooling for optimal thermal efficiency and performance.

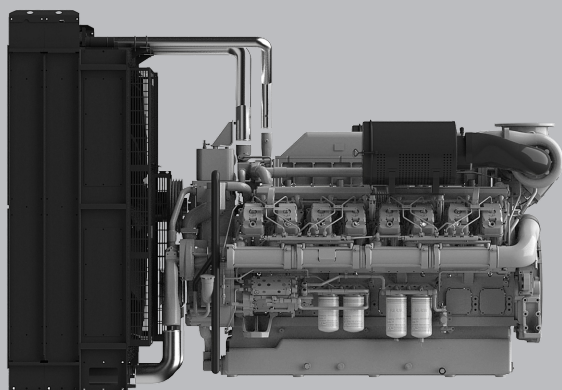

MAIN TECHNICAL PARAMETERS

Number of cylinders	16
Configuration	V, 90°
Aspiration	Turbocharged water-air intercooled
Combustion system	Direct injection
Compression ratio	14:1
Bore × Stroke	152mm x 180mm
Displacement	52.3L
Rotation	Counterclockwise (viewed from the flywheel end)
Fuel system	High Pressure Common Rail
Governor	ECU
Stability at constant load [ISO 8528-5 Class G3]	± 0.5 %
50/60Hz switchable operation	NO
Electric system	24V
Tropical Radiator mounted on the engine	Ambient 50°C
Flywheel Housing	SAE0 /18"
Lubrication Oil capacity	310L
Coolant capacity	547L
Emission class compliance	Stage III

THE ENGINE PERFORMANCE

GROSS ENGINE OUTPUT 50HZ

PRP/DCP	1805 kWm
ESP	1985 kWm

TYPICAL GENERATOR OUTPUT 50HZ

PRP/DCP	1600 kWe
PRP/DCP	2000 kVA
ESP	2250 kVA

FUEL CONSUMPTION

STANDBY [ESP]	201.9 g/kWh	481.0 L/h
PRIME [PRP/DCP]	196.6 g/kWh	425.5 L/h
75% PRP/DCP [prime]	191.3 g/kWh	207.3 L/h
50% PRP/DCP [prime]	191.1 g/kWh	309.0 L/h
HVO synthetic fuel acceptance		

KEY FEATURES

MAIN FEATURES

- ✓ Compact design
- ✓ Good power density
- ✓ Good load acceptance
- ✓ Durability
- ✓ Easy service & maintenance
- ✓ Low fuel consumption
- ✓ Wide selection of optional equipment
- ✓ Low noise
- ✓ Tailored cooling pack

STANDARD SCOPE OF SUPPLY

- ✓ Cast iron cylinder block c/w separate cast iron cylinder heads
- ✓ Aluminum alloy pistons with gallery oil cooling
- ✓ Automatic belt tensioner, Lift eyes, Fixed front & rear suspension
- ✓ Radiator with mechanical pusher fan, thermostatically controlled
- ✓ Large capacity oil pan, spin-on full-flow oil filter, oil dipstick
- ✓ High-pressure common rail
- ✓ ECU management/monitoring
- ✓ Duplex fine fuel filter c/w water separator
- ✓ Air inlet preheater
- ✓ Rear mounted turbochargers
- ✓ Top/Side mounted air filters with restriction indicator
- ✓ 24V DC electric system with two starters 8.5kW each
- ✓ 55A charging alternator
- ✓ Heat isolated exhaust manifold

DIMENSIONS & WEIGHT

DIMENSIONS & WEIGHT

Including radiator (dry weight)

3500

Length (mm)

2200

Width (mm)

2470

Height (mm)

6520

Weight (kg)

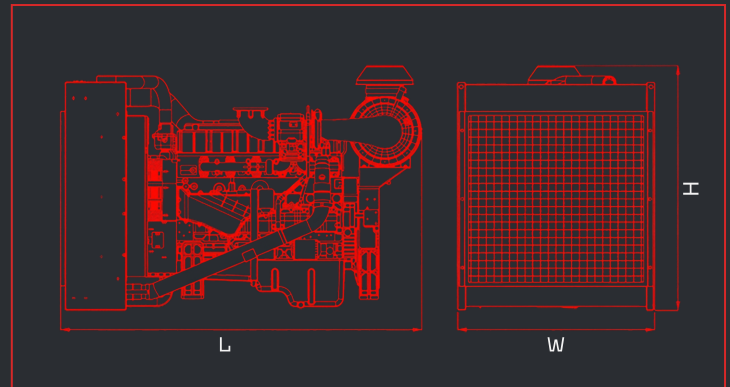

POWER DEFINITIONS:

ESP = STANDBY POWER

PRP = PRIME POWER

DCP = DATA CENTER POWER

According to ISO8528 is maximum power available during variable electrical power sequence up to 200h of operation per year, permissible output over 24h operation should not exceed 70% ESP

According to ISO8528 is maximum power engine can deliver continuously for unlimited number of hours per year permissible output over 24h operation should not exceed 70% PRP

It corresponds to the data center power (DCP) of GB/T 2820 and ISO 8528, and refers to the maximum power that the engine can provide for variable or continuous electrical loads under conditions of unlimited operating time, with the maintenance intervals and procedures being carried out as prescribed by FOGO. The generator unit is only applicable to the backup power supply of the data center. Prolonged operation at load in parallel with a utility is not permitted.

FOGO.PL

**INTERNATIONAL
WARRANTY**

PRIME / DATA CENTER POWER
2 years with
no hours limitations

STANDBY POWER
4 years or max. 1000 hrs
not more than 300 hrs per year