

ONE BRAND. ONE POWER.

TOTAL CONTROL

2005KW

Stage III

12 cylinders

FOGO GENSET ENGINE

F0792-2253

The F0792-2253 is a high-performance 12-cylinder diesel engine delivering 1800 kW of prime power output. With a 79.2L displacement and advanced engineering, this engine provides reliable power for diverse applications.

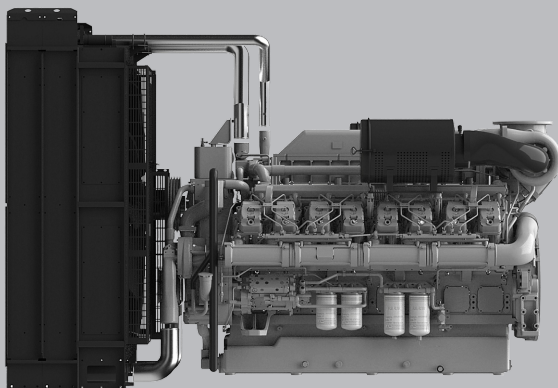

MAIN TECHNICAL PARAMETERS

Number of cylinders	12
Configuration	V, 90°
Aspiration	Turbocharged air-air intercooled
Combustion system	Direct injection
Compression ratio	13.5:1
Bore x Stroke	200mm x 210mm
Displacement	79.2L
Rotation	Counterclockwise (viewed from the flywheel end)
Fuel system	Electronic Pump Units
Governor	ECU
Stability at constant load [ISO 8528-5 Class G3]	± 0.5 %
50/60Hz switchable operation	NO
Electric system	24V
Tropical Radiator mounted on the engine	Ambient 50°C
Flywheel Housing	SAE00 /21"
Lubrication Oil capacity	370L
Coolant capacity	679L
Emission class compliance	Stage III

THE ENGINE PERFORMANCE

GROSS ENGINE OUTPUT 50HZ

PRP/DCP	2005 kWm
ESP	2206 kWm

TYPICAL GENERATOR OUTPUT 50HZ

PRP/DCP	1800 kWe
PRP/DCP	2250 kVA
ESP	2500 kVA

FUEL CONSUMPTION

STANDBY [ESP]	204.6 g/kWh	540.6 L/h
PRIME [PRP/DCP]	200.2 g/kWh	480.6 L/h
75% PRP/DCP [prime]	215.0 g/kWh	258.1 L/h
50% PRP/DCP [prime]	202.4 g/kWh	364.4 L/h
HVO synthetic fuel acceptance		

KEY FEATURES

MAIN FEATURES

- ✓ Compact design
- ✓ Good power density
- ✓ Good load acceptance
- ✓ Durability
- ✓ Easy service & maintenance
- ✓ Low fuel consumption
- ✓ Wide selection of optional equipment
- ✓ Low noise
- ✓ Tailored cooling pack (optional)

STANDARD SCOPE OF SUPPLY

- ✓ Cast iron cylinder block c/w separate cast iron cylinder heads
- ✓ Aluminum alloy pistons with gallery oil cooling
- ✓ Automatic belt tensioner, Lift eyes, Fixed front & rear suspension
- ✓ Radiator with mechanical pusher fan, thermostatically controlled (optional)
- ✓ Large capacity oil pan, spin-on full-flow oil filter, oil dipstick
- ✓ Electronic Pump Units fuel system
- ✓ ECU management/monitoring
- ✓ Duplex fine fuel filter c/w water separator
- ✓ Air inlet preheater
- ✓ Rear mounted turbochargers
- ✓ Top/Side mounted air filters with restriction indicator
- ✓ 24V DC electric system with two starters 11kW each
- ✓ 55A charging alternator
- ✓ Heat isolated exhaust manifold

DIMENSIONS & WEIGHT

DIMENSIONS & WEIGHT

Including radiator (dry weight)

5500

Length (mm)

2500

Width (mm)

2500

Height (mm)

14200

Weight (kg)

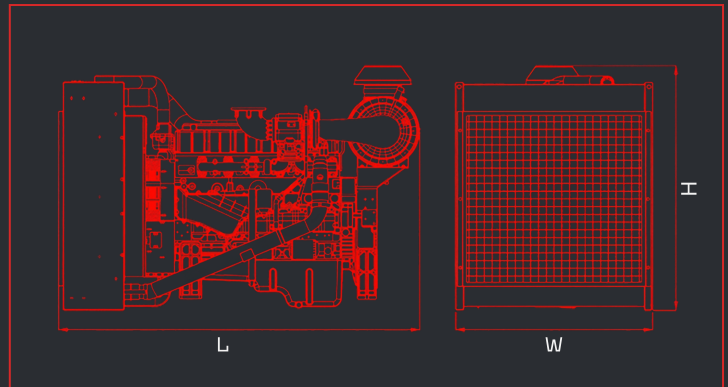

POWER DEFINITIONS:

ESP = STANDBY POWER

PRP = PRIME POWER

DCP = DATA CENTER POWER

According to ISO8528 is maximum power available during variable electrical power sequence up to 200h of operation per year, permissible output over 24h operation should not exceed 70% ESP

According to ISO8528 is maximum power engine can deliver continuously for unlimited number of hours per year permissible output over 24h operation should not exceed 70% PRP

It corresponds to the data center power (DCP) of GB/T 2820 and ISO 8528, and refers to the maximum power that the engine can provide for variable or continuous electrical loads under conditions of unlimited operating time, with the maintenance intervals and procedures being carried out as prescribed by FOGO. The generator unit is only applicable to the backup power supply of the data center. Prolonged operation at load in parallel with a utility is not permitted.

FOGO.PL

**INTERNATIONAL
WARRANTY**

PRIME / DATA CENTER POWER
2 years with
no hours limitations

STANDBY POWER
4 years or max. 1000 hrs
not more than 300 hrs per year